

ElektroBank 14 Installer Manual



Note: This manual should only be used by trained installers that have been certified by Empower Energy. Access to the Empower Installation Dashboard is required to complete commissioning, and a login is only provided to certified installers. To become a certified installer, you must complete a formal training process. Further information about the process is described in document 9000066 Empower Installer Certification Process which can be found at www.empowerenergy.com.au.

Empower Energy Pty Ltd
Unit 7, 81 Frenchs Forest Road East
Frenchs Forest, NSW, 2086
Australia
www.empowerenergy.com.au
Office: +61 (0)2 8745 8821
Installation Support: +61 (0)2 8745 8835

AMENDMENT RECORD		
Issue Number	Date	Description
1.0	4 th Dec 2020	First draft release sent to Austest for validation
2.0	22 nd Apr 2021	Updated to meet all safety standards and CEC listing requirements
3.0	16 th July 2021	Replaced Backup RCD Type B requirement with RCD Type A requirement. Added 2 nd option to protective earthing option
4.0	31 st Jan 2022	Updated to meet new 4777.2:2020
5.0	2 nd Mar 2022	Updated for public release
6.0	3 rd July 2022	Updated I _{sc} PV from 15A to 19A. Added info on external PV meter
7.0	6 th July 2022	Updated PF to +/-0.6 as tested in 4777.2:2020
8.0	4 th Aug 2022	Updated company address
9.0	26 th Mar 2024	Major Update
10.0	15 th Apr 2024	Additional detail to several sections
11.0	1 st May 2024	Added screenshot of AS4777 Grid Configuration, reduced bottom clearance requirement, reminder to remove rubber feet, added acceptability of a single 4 pole isolator (two poles for each MPPT).

Associated / Referenced Documents		
Issued By	Document no.	Document title
Empower	9000066	Empower Installer Certification Process
Empower	1000495	Application Note Understanding Battery Backup and Sizing

Associated / Referenced Standards	
Document no. / Revision no.	Document title
AS/NZS 3000:2018	Electrical installations - Known as the Australian/New Zealand Wiring Rules
AS/NZ 5139:2019	Electrical installations - Safety of battery systems for use with power conversion equipment
AS/NZS 4777.1:2016	Grid connection of energy system via inverters – Part 1: Installation requirements
AS/NZS 4777.2:2020	Grid connection of energy systems via inverters, Part 2: Inverter requirements

1 Table of Contents

1 TABLE OF CONTENTS	3
2 MARKINGS & SYMBOLS	5
3 NOTICE, CAUTION, WARNING & DANGER CALLOUTS	5
3.1 Battery Markings	6
4 EXTERNAL RCD REQUIREMENTS	6
5 WARNINGS	7
6 DIMENSIONED DRAWING	8
7 PACKING LIST	9
7.1 Part Numbers.....	9
8 BALANCE OF SYSTEM (BOS) TO BE SUPPLIED BY THE INSTALLER	10
9 SITE INFORMATION REQUIRED	11
10 MOUNTING THE UNIT	12
10.1 Wall Mount	13
10.2 Install wall bracket	13
10.3 Mount wall bracket on wall	14
10.4 Mount unit on wall bracket.....	14
10.5 Floor Mount	15
10.6 Battery Installation.....	17
10.7 Close and fasten door	19
11 WIRING	21
11.1 External Isolation Device Requirements	21
11.2 Port Locations	22
11.3 Ferrite Attachments	22
11.4 Grid Port Including Protective Earthing	22
11.5 Backup Port.....	23
11.6 Voltage Backfeed Warning.....	24
11.7 UPS Safety Stickers	24
11.8 PV Ports.....	25
11.9 DRMO	26
11.10 Ethernet.....	26
12 METER CONNECTIONS	27
12.1 Main Consumption Meter	27
12.2 External PV Meter (ADL400N-CT/D16).....	31
13 COMMISSIONING	33
13.1 Closing Unit.....	33
13.2 Installer Dashboard.....	34
13.2.1 Prerequisites	34
13.2.2 Accessing the Installer Dashboard	34
13.2.3 Adding a unit to the Installer Dashboard	34
13.2.4 Connect to the ElektroBank	35
13.2.5 Upgrade Firmware.....	35
13.2.6 Battery Initialisation.....	36
13.2.7 Network Settings	36
13.3 Installation Wizard	37
13.3.1 Installation Wizard: Start.....	37
13.3.2 Installation Wizard: Site Details	37
13.3.3 Installation Wizard: Verification.....	38
13.3.4 Installation Wizard: Summary.....	38
13.3.5 After Commissioning	39
13.4 Before Leaving Site	40
13.4.1 Remove rubber feet.....	40
13.4.2 Earth Fault Alarm.....	40

13.4.3 User Training	40
13.4.4 Changing inverter settings.....	42
13.4.5 Viewing Read-Only Settings	43
14 MAINTENANCE.....	44
14.1 User Maintenance	44
14.2 Trained Service Professional Maintenance	44
14.2.1 Turning OFF the Unit.....	44
14.2.2 Turning ON the Unit.....	44
15 ELECTRICAL RATINGS	46
16 APPENDIX A - METER PROGRAMMING	47
16.1 Programming the ADL 400N meter	47
17 APPENDIX B – SINGLE PHASE WIRING DIAGRAM.....	48
18 APPENDIX C – LED CODES	49





2 Markings & Symbols

1. To identify the location where the operator's manual is stored or to identify information that relates to the operating instructions. To indicate that the operating instructions should be considered when operating the device or control close to where the symbol is placed.
2. To identify equipment that has risk of electric shock.
3. To identify energy storage timed discharge – that is the time required after disconnecting the unit from all energy sources and turning off the battery circuit breaker until the capacitor energy storage in the unit is less than 48VDC.
4. To indicate that caution is necessary when operating the device or control close to where the symbol is placed, or to indicate that the current situation needs operator awareness or operator action to avoid undesirable consequences.
5. To identify any terminal which is intended for connection to an external conductor for protection against electric shock in case of a fault, or the terminal of a protective earth (ground) electrode.



3 Notice, Caution, Warning & Danger Callouts

Empower Energy uses the following graphics to bring attention to hazards:

 Danger	High level hazard. Could result in death or serious injury.
 Warning	Low level hazard. Could result in minor or moderate injury.
 Caution	Process could damage the product or components.
 Notice	Highlights key information.

3.1 Battery Markings

Battery Type	Secondary (rechargeable) Li or Li-ion
Cell Designation	IFpP/34/201/173/M/-10+40/90
Module Designation	IFpP34/201/173[8S]M/-10+40/90
Battery System Designation	IFpP34/201/173[48S]M/-10+40/90
System Capacity	100Ah
Nominal Voltage	153.6V
Watt-hour	15.36kWh
Caution Statement	WARNING! A battery can present a risk of electrical shock, fire, or explosion from vented gases. Observe proper precautions.
Disposal	 <p>Electronic Device: Do not throw away</p> <p>Proper disposal of batteries is required. Refer to your local codes for disposal requirements.</p>
Recommended Charge instructions	Charging is only allowed using the provided ElektroBank 14 system, do not try charging with a different charger.

4 External RCD Requirements



This product requires external RCD Type A, 30mA protection for all circuits powered by the backup port

5 Warnings



1. When the photovoltaic (PV) array is exposed to light, it supplies a DC voltage to the PCE.
2. External RCD Type A 30mA is required on backup port (if connected).
3. An RCD is not permitted on the grid/supply side of the device as it is a multi-mode inverter and an RCD would allow disconnection of the neutral MEN connection for backup loads.
4. It is required that any PV modules connected to the device have an IEC 61730 Class A rating.
5. If the equipment is used in a manner not specified by the manufacturer, the protection provided by the equipment may be impaired.
6. Only an installer certified by Empower Energy may install the ElektroBank 14.
7. Servicing or replacement of batteries shall not be conducted in the field by anyone other than Empower personnel, unless explicitly permitted by Empower in writing. Initial installation is allowed as per this manual.
8. CAUTION: Do not dispose of batteries in a fire. The batteries may explode.
9. CAUTION: Do not open or damage batteries. Released electrolyte is harmful to the skin and eyes. It may be toxic.
10. CAUTION: The backup port should not be used for devices providing safety or health critical devices.
11. Touch current is above the limit. Ensure PE cable used for protective earth conforms to either option a) or b) below:
 - a. Made of copper and 10mm² or greater (but less than 16mm²).
 - b. One 6mm² minimum earth cable into 'Grid' terminal block and a second 6mm² earth cable into 'Backup' terminal block, of the same cross-sectional area.



1. SAFE HANDLING: ElektroBank 14 and battery modules are heavy. To minimise risk when handling the goods, lift and transport the goods carefully and wear personal protective equipment such as steel-toe boots and gloves. Use of lifting equipment is recommended.
2. SAFE TRANSPORT: Always transport the goods to site in the original packaging. During unpacking, inspect the goods for damage such as large dents or deep scratches, which may indicate the unit was dropped. Do not use ElektroBank 14 if it is defective or appears damaged in any way, internal or external. Contact your supplier for further advice.
3. The ElektroBank 14 cannot be used in multiple inverter combinations as per Section 5 of the AS/NZS 4777.2:2020.

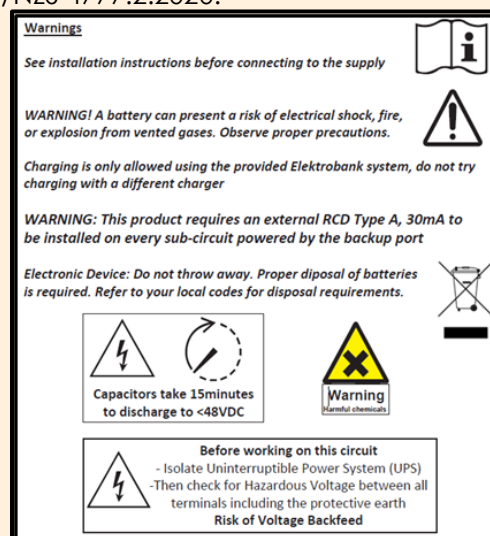
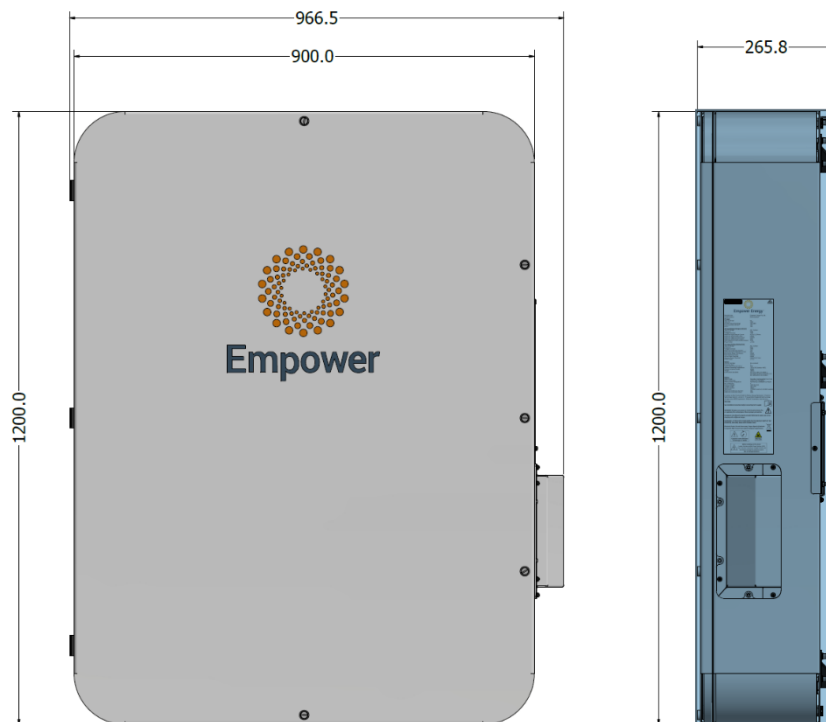

Figure 1 – Product label warnings

6 Dimensioned Drawing



Note: Floor Mount Kit (Refer to Figure 6) is an optional extra and will only be supplied upon request.

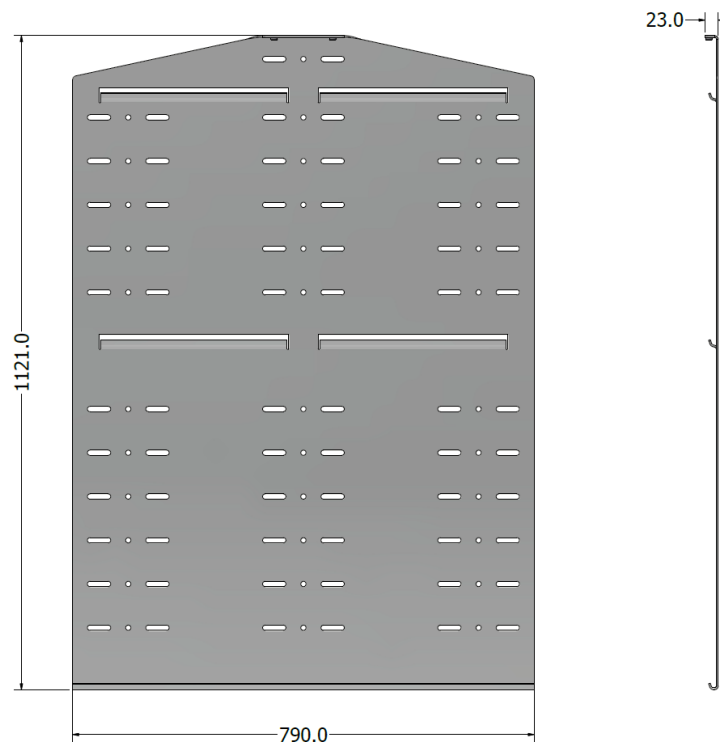

Figure 2 - Dimensions of the ElektroBank 14 and the wall mount bracket

7 Packing List

The ElektroBank 14 is manufactured in Malaysia and contains the following parts:

1. Main Enclosure box, including:
 - a. Main Enclosure
 - b. Wall Mount Bracket
 - c. Installer Manual
 - d. Polythene Bag containing
 - i. 28x M6 Battery Mounting bolts.
 - ii. 28x M6 Battery Mounting Washers.
 - iii. Assortment of glands and plugs for cable entry.
 - iv. EMC Ferrites for grid, backup and ethernet wires.
 - v. 4x Phoenix Contact PV Connectors.
2. Front of House Meter – PN: "Acrel ADL400N-CT/D16 (EMP)" meter which includes 3x current transformers.

Note: The supplied ADL400/C (inside the main enclosure box) should NOT be installed. Empower has discontinued support for the ADL400/C and now only supports the Acrel ADL400N-CT/D16 (EMP) meter, which is supplied separately to the main enclosure box
3. Battery 1
4. Battery 2
5. Battery 3
6. Battery 4
7. Battery 5
8. Battery 6
9. (Optional) Floor Mount Kit will be supplied upon request

7.1 Part Numbers

Item	Part No.
Main Enclosure	"EB" followed by a 12 digit numeric code. E.g. EBXXXXXXXXXX
Front of House Meter	Acrel ADL400N-CT/D16 (EMP)
External PV Meter (to be supplied by installer)	Acrel ADL400N-CT/D16
Batteries 1 through 6	A QR code describing a 24 Digit code
Floor Mount Kit	PN30186

8 Balance of System (BOS) to be supplied by the installer

Item	Usage Case
Selection of circuit breakers (32A, 10A, 20A etc.)	All sites
External RCD Type A, 30mA protection	For sites with backup circuits
Hager contactor ESC465	For sites with backup circuits
External PV Isolators	For sites with solar panels. Note: A single physical isolator or two separate isolators can be used if they meet the AS5139 standard.
ADL400N meter (PN: ADL400N-CT/D16) configured per Section 12	For sites with separate AC Coupled PV inverters installed onsite (e.g. in addition to the ElektroBank 14). Note: The Front of House Meter looks the same but has slightly different internal hardware and has a an "EMP" designation at the end of its part number: "Acrel ADL400N-CT/D16 (EMP)". Refer to Section 12 for how these meters are different.

9 Site Information Required

To complete installation and commissioning, the below information will be required for entry into the Installation Wizard.



Notice

It is critical that you have the NMI number prior to going to site, as many times the meters are not labelled onsite. The easiest way to find the NMI is on the end-user's electricity bill.

Category	Item	Site Details
Site	NMI	
	Address	
	DNSP	
	Unit SN#	
	Phases (1, 2, or 3)	
	SA Only: Flexible Export or Fixed?	
	<ul style="list-style-type: none"> If Fixed, who is the Relevant Agent? 	
Customer	Full Name	
	Email address	
	Wi-Fi or Ethernet?	
	Wi-Fi Name	
	Wi-Fi Password	
	Yes/No	
	Type of backup wiring/equipment	
External PV	Yes/No	
	Inverter Count	
	Inverters on different phases? (yes/no)	
	Power of each inverter	
Internal PV (connected to ElektroBank)	Yes/No	
	PV Array Power	
	Panel Brand/Model/Power	
	MPPT 1 - Panel count (Power)	
	MPPT 1 – Calculated Voc / Isc	
	MPPT 2 - Panel count (Power)	
	MPPT 2 – Calculated Voc / Isc	

Table 1 - Site Information Required

10 Mounting the Unit



Danger

Installation shall follow and comply with AS/NZS 5139, AS/NZS 3000 as well as any requirements from this manual

1. Find a suitable mounting location as per AS 5139
 - A risk assessment for the mounting location shall be completed.
2. The ElektroBank 14 can be mounted on a wall with the wall mount kit or floor standing, with the addition of the floor mount kit.
 - The wall mount bracket shall always be used.
 - The wall shall always be capable of taking the full weight of the unit, whether wall mount or floor standing.
3. Mounting Location
 - The ElektroBank 14 is rated to IP66 so can be mounted inside or outside.
 - Do not mount the ElektroBank 14 in a location with direct sunlight. Outdoor suggested (but not limited to) locations include:
 - i. Under an awning
 - ii. On a South Facing wall
 - Ensure no animals or insects are likely to be able to nest close to the unit.
 - Installation position shall not prevent access to disconnection means.
 - Do not mount the ElektroBank 14 in a location that is exposed to artificial heat or cold sources produced by external elements such as hot water systems, heaters, air-conditioners or other power electronics devices (e.g batteries or inverters).
 - If indoor mounted,
 - i. Always follow local fire regulation. Empower recommends a fire alarm is installed in the same room as the ElektroBank 14.
 - ii. The room should be well ventilated as per AS5139.
4. ElektroBank Clearance Requirements
 - No plants can be growing inside 1m radius from the mounting location
 - Ensure there are no obstructions (to ensure adequate heat dissipation and to simplify connections) inside the dimensions from Figure 3, including, but not limited to:
 - i. Wall, floor, Ceiling/roof.
 - ii. Any other devices or equipment.
 - iii. Any Heat sources.
 - iv. Note: Bollards can be installed within these clearances if the enclosure door can still be opened and the inside of the unit accessed safely.

Recommend 1.0m minimum clearance at the front of unit to allow for the door to open.

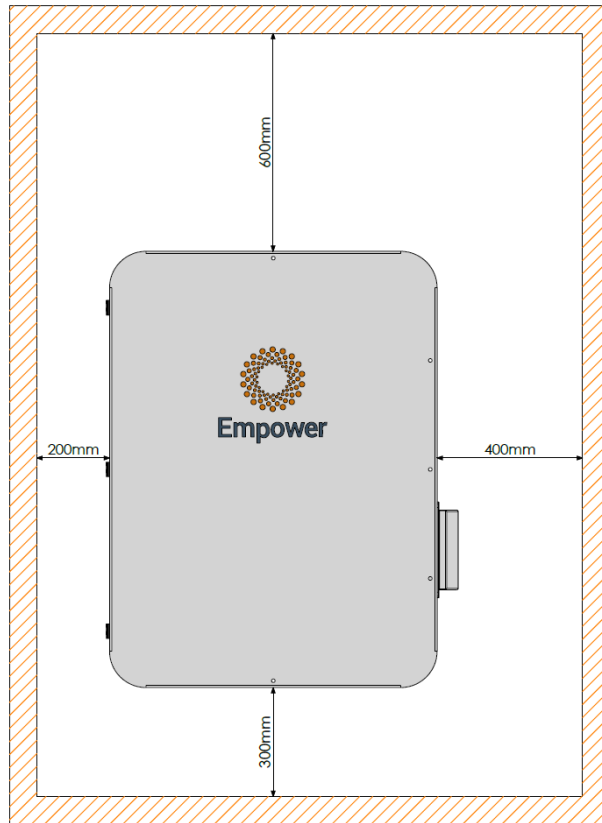

Figure 3 - Required clearance space around the ElektroBank 14

10.1 Wall Mount

1. Conform to AS/NZS 5139 requirements and conduct risk assessment on mounting method.
2. Ensure the wall is vertical and flat across the full width and height of the ElektroBank 14.
3. Ensure the wall is structurally sound to take the weight of the ElektroBank 14.
4. Remove external packaging and remove wall mount bracket from packaging.

10.2 Install wall bracket

Determine mounting method from below or equivalent minimum total Working Load Limit (WLL) 6kN, minimum 6 fasteners (12 into wood).

Notes:

1. Mounting methods in Table 2 are examples only. AS/NZS 5139 requires a risk assessment.
2. New Zealand has additional seismic requirements in AS/NZS 5139.
3. High quality 316 stainless steel fixings are strongly recommended for long term corrosion resistance.

Wall Material	Anchor Type	Product Example	Quantity
Solid brick or concrete, with no risk of internal voids	AnkaScrew M8x100 mm	Ramset Australia AS08100WGM	At least 6 per system
Brick or concrete with internal voids	M8 glue in studs with sleeves	<ul style="list-style-type: none"> • Ramset Australia CS08110GH • Ramset Australia ISS08 • Ramset Australia Chemset 101 PLUS (Curing time is around 50 minutes) 	At least 6 per system
Timber	Coach screws M8x100mm	Zenith M8 x 100mm Stainless Steel Hex Head Coach Screw	At least 12 per system

Table 2 - Anchoring based on wall material

10.3 Mount wall bracket on wall

- Use spirit level to ensure bracket is level.
- If fixing into a timber framed wall, the wall bracket must be secured into two different vertical studs. It has been designed to span the standard spacing of 600mm.

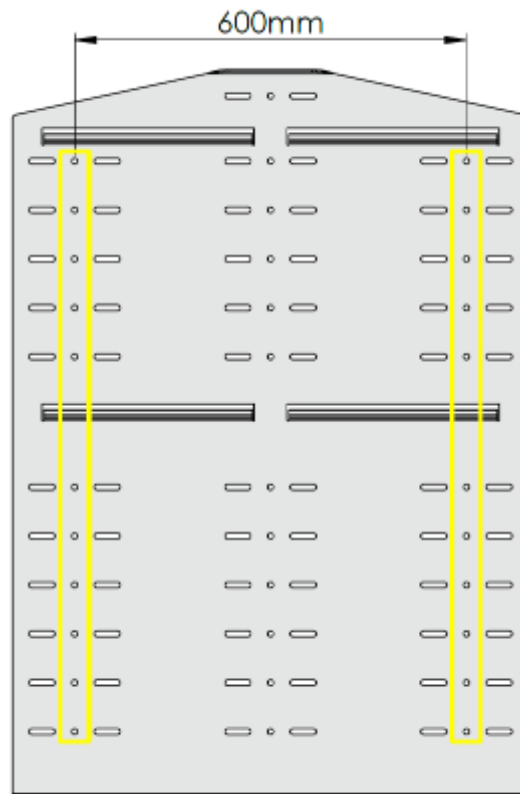

Figure 4 - Wall Mount Bracket Fixing Locations

10.4 Mount unit on wall bracket

1. Using a two-man lift, place the ElektroBank 14 onto the wall bracket.
2. Secure the wall bracket to the top of the enclosure with the 2x supplied M6 screws as per Figure 5.

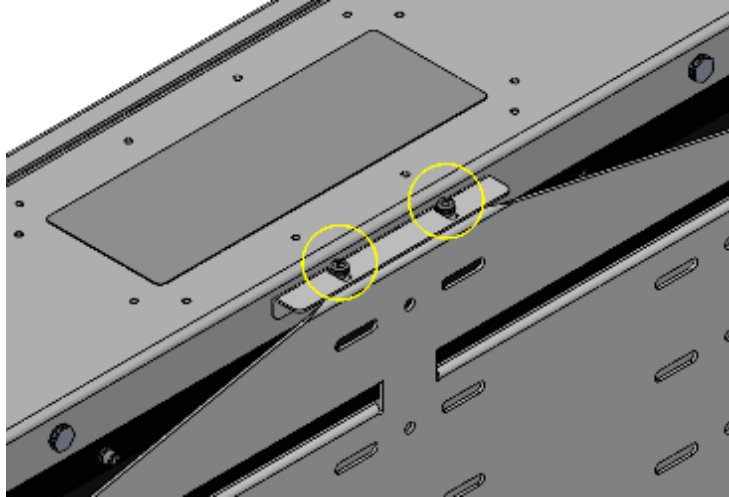

Figure 5 - Top fixing bracket

10.5 Floor Mount



Caution

DO NOT use the included rubber feet for ground mounting. The rubber feet are attached to the enclosure at the factory to assist with manoeuvring the unit onsite and prevent scuffing. The rubber feet must be removed once the unit is mounted to the wall. A Floor Mount Assembly kit is required for ground mount installation.

1. Floor Mount Assembly is available to order as a separate item from your distributor and consists of the following items:
 - a. 2x M10 Stainless Steel Levelling Feet.
 - b. 4x M6x16 Stainless Steel SEMS Socket Head Bolts.
 - c. 2x Levelling Feet Supports.
2. Floor mounting is suitable when the wall is considered not completely structurally sound to mount the unit, this could be the case for many types of wooden structures or walls with plastic/wooden cladding or Besser/cinder blocks. Floor mounting is only viable when there is a suitable vertical structural member or wall to fix the wall bracket to that can take the full lateral load of the unit. The unit cannot be mounted freestanding. As per AS/NZS 5139 a risk assessment will be required to assess the suitability of the mounting method.
3. Floor mounting can only take place on a flat concrete base. A separate risk assessment shall be carried out to ensure the platform is structurally sound to mount the unit to.
4. Apply anti-seize compound ([Permatex P81343](#) or similar) to the last 20mm of thread on both levelling feet (WD-40 is not suitable for this application).
5. Install the rectangular mounting sections to the unit using the provided M6 bolts (5mm hex driver, max. torque 5Nm). Ensure the threaded insert for the levelling foot is pointing towards the front of the unit (Figure 6). The inner pairs of mounting holes can also be used if there are any obstructions. Mixing an outer mounting hole and inner mounting hole is not permitted.
6. Thread both levelling feet all the way in and then back off 1.5 turns.
7. The levelling feet have a maximum adjustment range of 10mm so accurate placement of the wall bracket in the following steps is critical.
8. Position the bracket on the wall ensuring that the bottom of the bracket is 150mm from the floor (Figure 7). Mark the desired mounting hole locations and install the mounting fasteners as per Table 2.
9. Lift the ElektroBank 14 onto the wall bracket and using a 17mm spanner, rotate the adjustment nut clockwise (Figure 8) until the feet begin to take the weight of the unit. Tighten the locknut using a second spanner once the desired position is obtained (max. torque 5Nm).

10. Secure the wall bracket to the top of the enclosure with the 2x supplied M6 screws as per Figure 5.

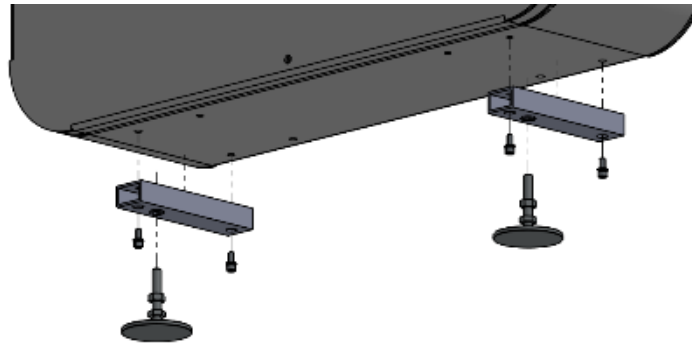

Figure 6 - Installation of levelling foot assembly.

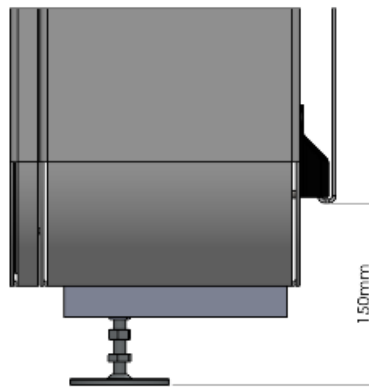

Figure 7 - Installation height of wall bracket.

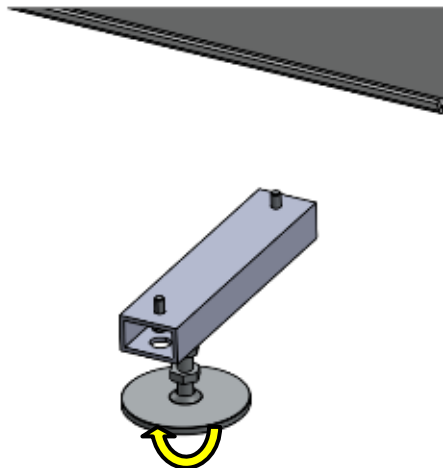

Figure 8 - Levelling foot adjustment direction.

10.6 Battery Installation



Before closing the door of the unit (and unless there is an automated method available) please record the serial number of each battery and share it with your supplier and Empower directly at support@empowerenergy.com.au.



Figure 9 – Installed ElektroBank 14 battery modules showing location of serial number QR Code

1. Before starting, ensure the enclosure is securely fixed (wall mounted or floor mounted) as per above instructions.
2. Ensure all internal covers are still attached.
3. Ensure all circuit breakers are off and the unit is completely isolated from mains and PV.
4. Specifically, ensure that the integrated battery circuit breaker is turned OFF to ensure isolation (Figure 10).

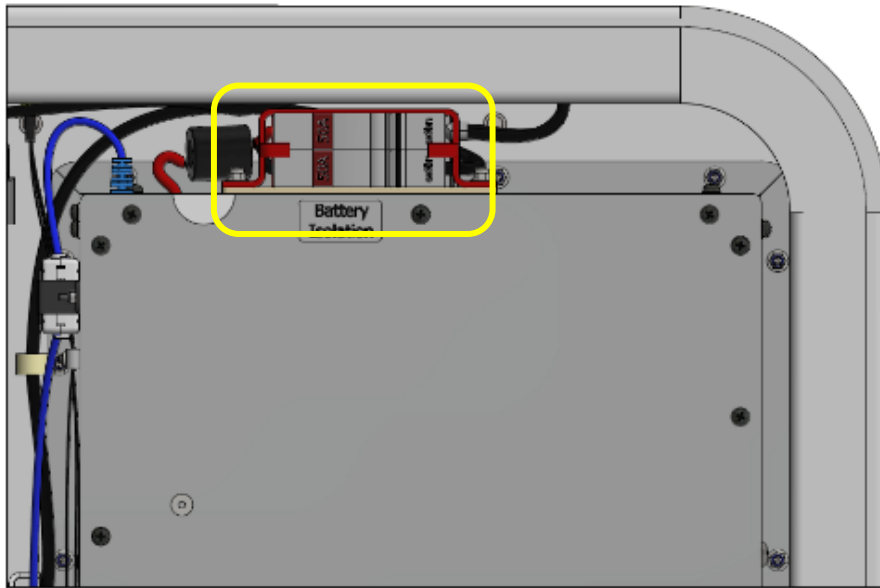

Figure 10 - Ensure breaker is OFF

5. Fit the battery modules in the below order, ensuring not to trap any wires behind each module and to fix the module before fitting the next module, using the long M6 bolts provided, tighten to approximately 1Nm.
 - a. Battery 5 – bottom left
 - b. Battery 6 – bottom right
 - c. Battery 3 – middle left
 - d. Battery 4 – middle right
 - e. Battery 1 – top left
 - f. Battery 2 – top right
6. Fit washers provided and tighten all the 24 mounting bolts to 5Nm +/- 1Nm.
7. Connect the fuel gauge temperature sensor from battery 6 to the master BMS as shown below:

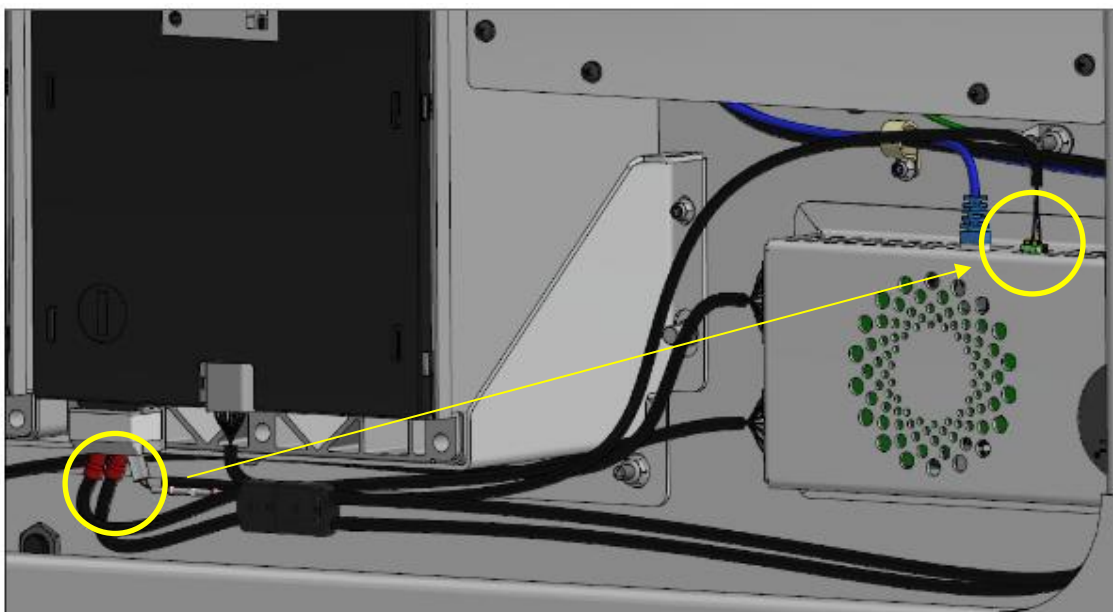

Figure 11 - Fuel gauge temperature sensor connection from battery 6 to the master BMS

8. Connect all the modules together, starting at the bottom left-hand blue connector and working upwards.

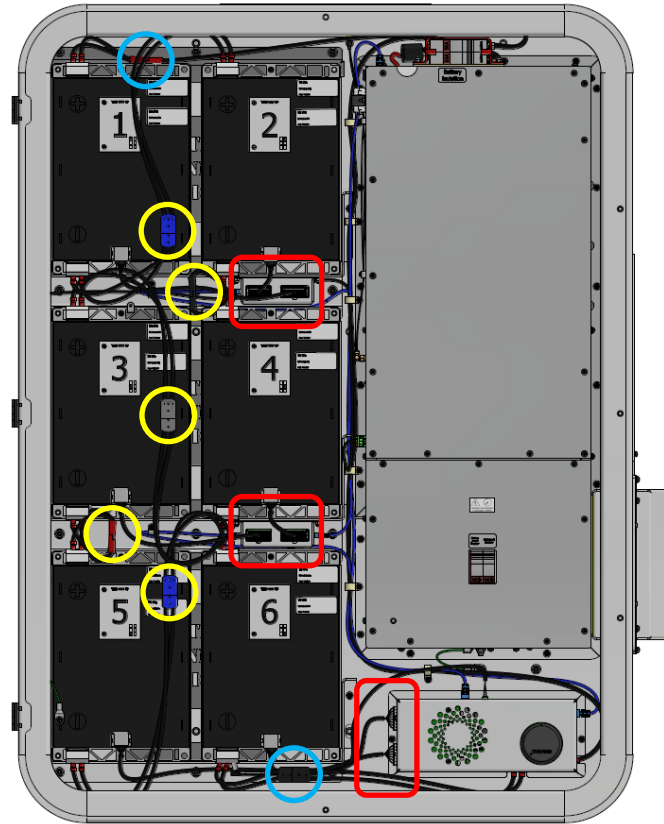

Figure 12 - Module Connections and BMS Connectors

9. First, connect the 3x 16-pin BMS connectors, then the 3x 14-pin BMS connectors, in both cases, working from the bottom up (Figure 12 circled in red).
10. Finally, connect the battery stack connections, the black connector at the bottom and then the red connector at the top (Figure 12 circled in blue).



DO NOT plug the 14-pin connector into the 16-pin receptacle. It will permanently damage the unit. Empower will detect this failure remotely and will void the warranty. The way to avoid this is to always connect the larger 16-pin connectors first.

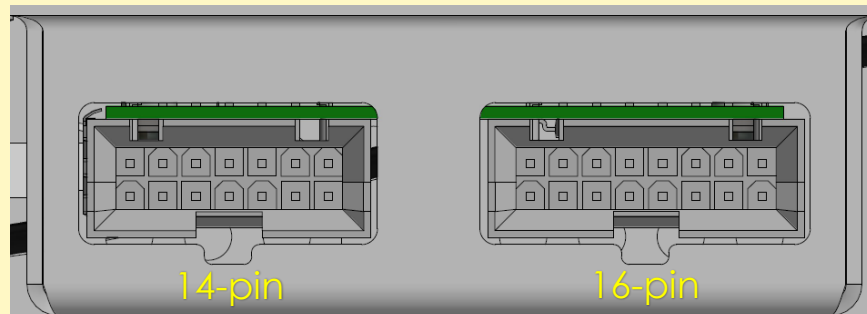

Figure 13 – BMS Connections

10.7 Close and fasten door

The following bolt sequence must be followed to ensure the correct seating and loading of the environmental seals:

1. Bolts shall be hand tightened first then torqued to 0.5Nm in the following sequence, starting from bolt 1 as shown:

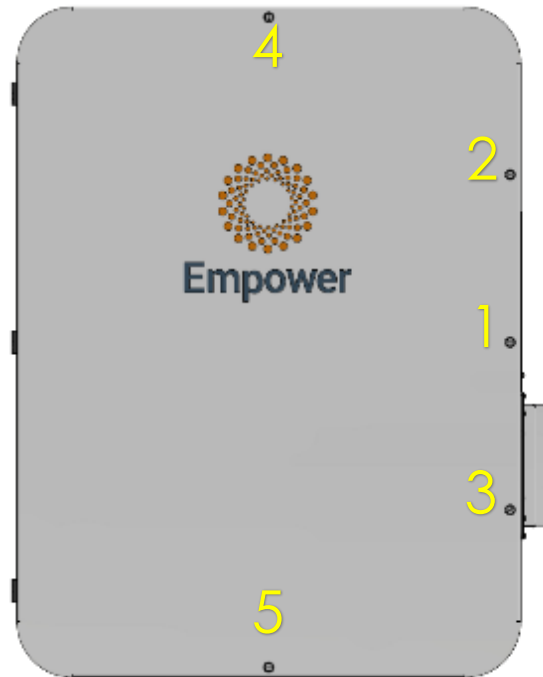

Figure 14: Bolt tightening sequence

2. Torque bolts to 1Nm in the same sequence.

11 Wiring



Danger

In addition to all requirements in this document, ensure all wiring conforms to AS/NZS 3000 and AS/NZS 4777.1 for Australia.

Refer to Appendix B – Single Phase Wiring Diagram for a single line diagram of the wiring.

Refer to Table 3 below for a connection summary:

Connection Name	Connection Type	DVC Class
PV	4 Sunclix External Connectors	DVC-C
Grid	2 x 6mm ² minimum Live and Neutral into terminal block	DVC-C
Backup	2 x 4mm ² minimum Live and Neutral into terminal block	DVC-C
Earth	Either a) or b) below a) Single earth cable made of copper and 10mm ² or greater (but less than 16mm ²) into 'Grid' terminal. b) One 6mm ² minimum earth cable into 'Grid' terminal block and a second 6mm ² earth cable into 'Backup' terminal block of the same cross sectional area.	DVC-A
LAN	RJ45	DVC-A
DRM0	2 wires into terminal block	DVC-A
Meter RS-485	2 wire twisted pair into terminal block	DVC-A

Table 3 - Connection Summary

11.1 External Isolation Device Requirements

The following isolation devices are required:

1. 32A single pole circuit breaker for grid port, connected to active conductor only.



Warning

Never put a circuit breaker/RCD on the supply/grid side neutral conductor otherwise it may disrupt the continuity of the neutral to the backup circuits.

2. A double pole solar PV isolator (suitably rated and certified) for each MPPT or a single physical isolator (suitably rated and certified) with two poles for each MPPT (4 poles total).
3. If backup circuits are connected, then this product requires:
 - a. A 20A circuit breaker on the output of the backup port to protect the inverter.
 - b. External RCD Type A, 30mA protection for all circuits powered by the backup port.



Notice

Empower recommends the Hager ESC465 contactor for best customer experience to isolate from the grid. Contactor failures have been observed when low quality contactors have been used. Refer to 1000495 Application Note Understanding Battery Backup and Sizing for further information and guidance. Do not wire backup circuits to go through the Elektrobank with no bypass.

11.2 Port Locations



Figure 15 - Port Locations

11.3 Ferrite Attachments

1. Grid Active and Neutral Cables Only – both cables through core and then 2 turns - Wurth Part Number 74271211 or the supplied 742700790
2. Backup (if used) Active and Neutral Cables Only - both cables through core and then 2 turns of the supplied Wurth Part Number 742700790
3. Ethernet Cable – 2 turns of Wurth Part Number 74271112

11.4 Grid Port Including Protective Earthing

1. **Cable used for protective earth shall conform to option a) or b) below:**
 - a. **Made of copper and 10mm² or greater (but less than 16mm²)**
 - b. **One 6mm² minimum earth cable into 'Grid' terminal block and a second 6mm² earth cable into 'Backup' terminal block, of the same cross-sectional area.**
2. Use minimum 6mm² cable for the grid port active and neutral connections.
3. Only Copper wire is suitable for use.
4. Make sure all grid/earth cabling is rated for outdoor use as per local standards. Recommend running all external cabling in conduit. Connect cable as in the below image, live (L), neutral (N) and earth (earth symbol) to terminal block as marked.

5. Ensure the main $>10\text{mm}^2$ minimum earth wire is longer than the live and neutral wire so that if the cable pulls out the earth wire is the last to be disconnected, It shall be connected to one of the Grid connector Earth points. The spare Earth port can be used for a second earth that may be present in the twin core and earth cable used.
6. The wires shall be stripped to 18mm and the connections are push fit spring connections.
 - a. Insert, push until no copper can be seen and then do an approximately 1kg pull test and confirm no copper can be seen.
7. At this stage confirm all grid cables, especially earth is well connected mechanically and confirm with multimeter that the enclosure has continuity to earth.
8. Ensure gland is tightened to IP66 (note – do not replace gland that is provided with the unit)

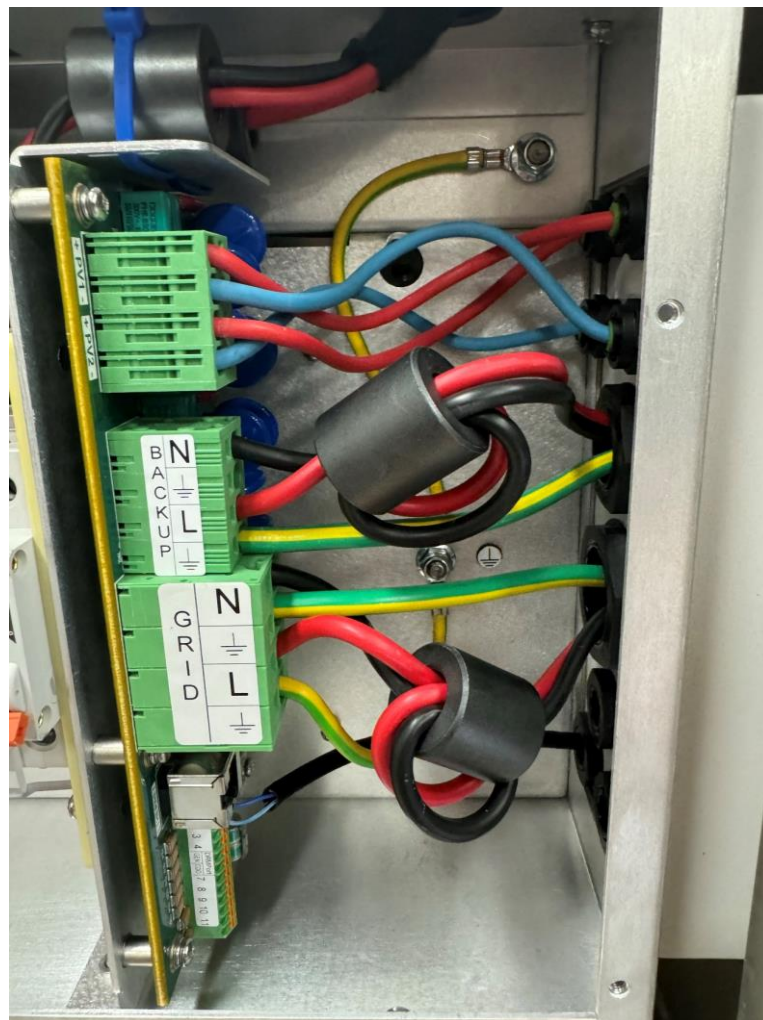

Figure 16 - Grid and Backup Connections

11.5 Backup Port

1. Use minimum 4mm^2 cable for the backup and connect to the terminals as shown in Figure 16 - Grid and Backup Connections.

- a. Insert, push until no copper can be seen and then do an approximately 1kg pull test and confirm no copper can be seen.
2. The stripping length is 15mm and the connections are push-fit spring connections.
3. Outside the ElektroBank 14 the backup wiring should wire directly to a single pole Circuit breaker with 20A tripping current.
4. Then connect to a 63A minimum contactor (we recommend the ESC465) wired as shown in Appendix B – Single Phase Wiring Diagram
5. After the contactor, this product requires external RCD Type A, 30mA protection for all circuits powered by the backup port.

11.6 Voltage Backfeed Warning

Voltage Backfeed Warning Label, similar to Figure 17 - Voltage Backfeed Warning Label) shall be provided on the UPS input and on all primary power isolators installed remotely from the UPS (for example the circuit breaker in the backup circuit board) and on any external access points between the isolators and the UPS

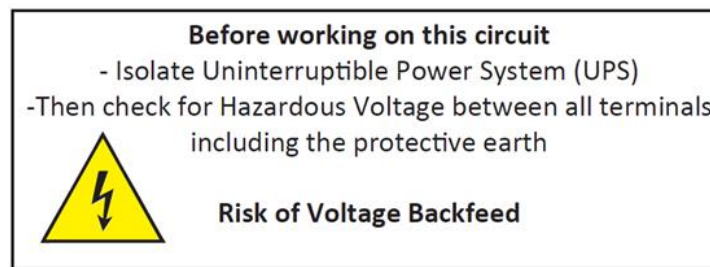

Figure 17 - Voltage Backfeed Warning Label

Maintaining Neutral Continuity to Earth:

1. The neutral input from the grid port is internally always connected through to the neutral output from the backup port.
2. Ensure that the neutral input to the grid port is only connected to earth at the single point back at the main fuse board (MEN connection)

11.7 UPS Safety Stickers

One UPS safety warning sticker is provided on the external of the unit, another two warning labels are provided. These should be placed adjacent to any isolation device on the backup and grid circuits and are shown below.

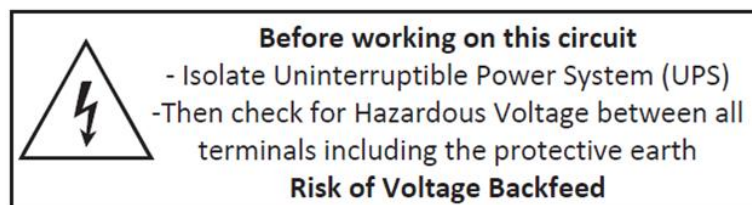

11.8 PV Ports



The ElektroBank 14 has a maximum input voltage of 430V. Panels need to be carefully selected to ensure Voc can never exceed 430V when taking into account the safety margins from AS/NZS 5033:2021 and according to the minimum site temperature.

The ElektroBank is a transformerless inverter so ensure the PV array is well insulated to earth before connecting it to the inverter

1. There are 2 sets of PV connectors, one for each MPPT.
2. Use the following connectors, ensure the right polarity wire is put into the correct connector.
3. Connect to the unit ensuring a single MPPT is connected across the PV1 connectors and the second MPPT is connected across PV2 connectors.

Negative Polarity – Phoenix Contact:

- PV-CM-S 2,5-6
- P/N: 1774687
- <https://www.phoenixcontact.com/online/portal/nz/?uri=pxc-oc-itemdetail;pid=1774687&library=nzen&pcck=P-20-06-12&tab=1&selectedCategory=ALL>

Positive Polarity – Phoenix Contact:

- PV-CF-S 2,5-6
- P/N: 1774674
- <https://www.phoenixcontact.com/online/portal/nz/?uri=pxc-oc-itemdetail;pid=1774674&library=nzen&pcck=P-20-06-12&tab=1&selectedCategory=ALL>

11.9 DRM0

If required place 2 core DRM0 cable through gland and attach DRM0 (Blue) into pin 5 and DRM_RTN (black) into pin 6 of TR6.

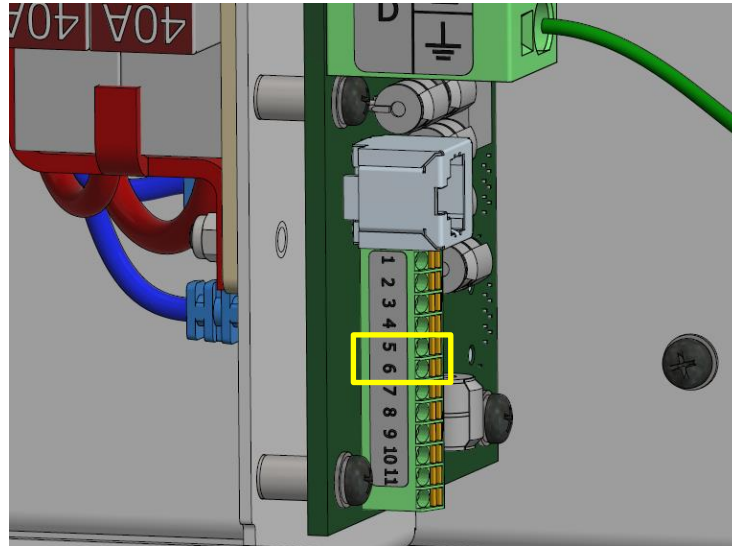

Figure 18 - DRM0 Connections

11.10 Ethernet

If the unit requires hard wiring to the LAN feed ethernet cable through gland, crimp on an RJ45 plug and connect to the RJ45 socket as shown (Figure 19).

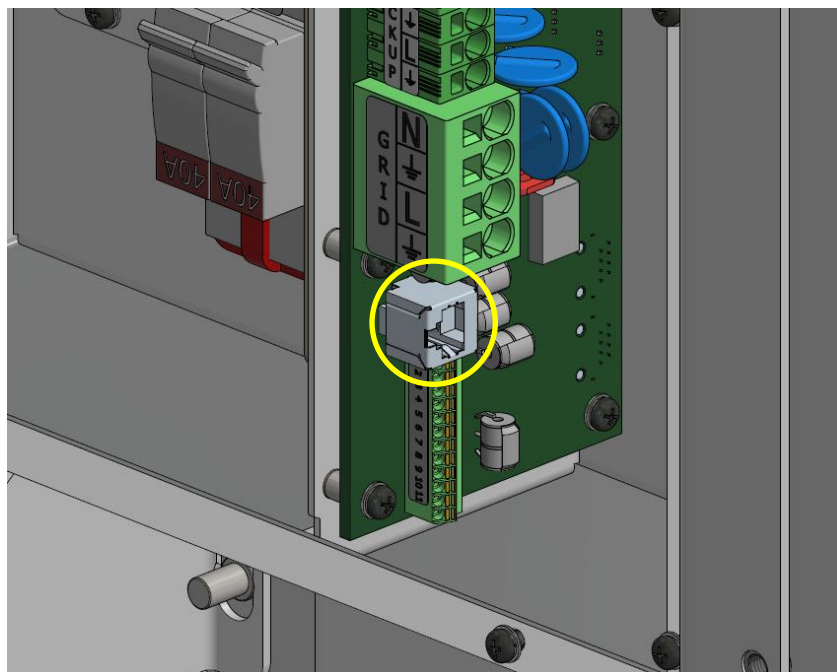

Figure 19 - Ethernet Connection

12 Meter Connections

For the main consumption meter, Empower Energy only supports the Acrel ADL400N-CT/D16 (EMP) meter which can be used for both single phase and 3-phase installations. This is a customised model specifically for Empower Energy and other variants cannot be used.



Empower Energy has discontinued support for the ADL400/C that is supplied in the main product packaging.

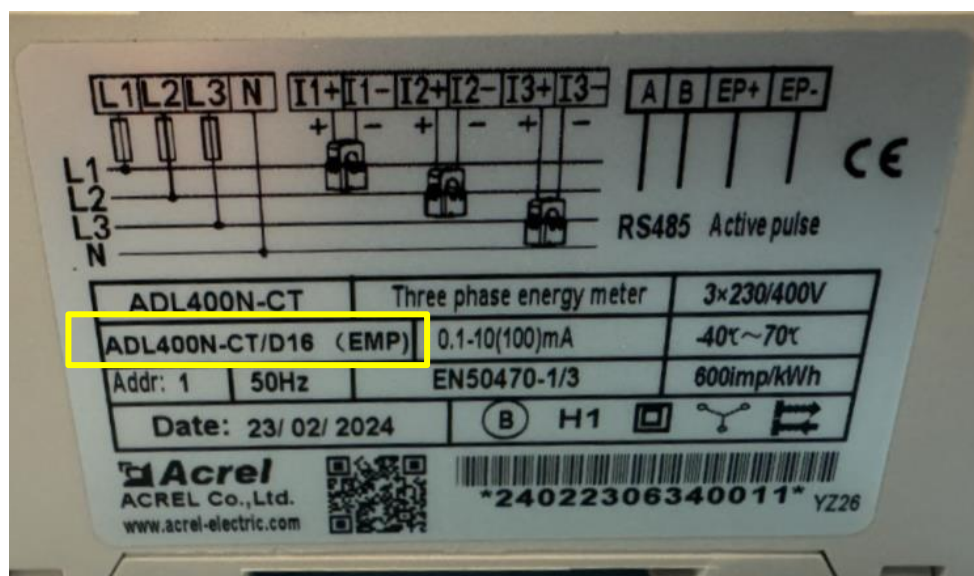

Figure 20 – ADL400N-CT/D16 (EMP)

For the main consumption meter (3-phase or single phase), the ADL400N-CT/D16 (EMP) must be used. This meter comes with preset baud rates and an address of 1. Where the site contains an external/independent PV Inverter, an additional ADL400N-CT/D16 must be installed (set to Address 2) for metering the solar production. Refer to Section 12.2.

12.1 Main Consumption Meter

1. Install the meter in the switchboard.
2. For single phase the meter is powered from the grid between L1 and N.
 - a) Ensure a single pole 10A CB protects the meter.
3. For 3-phase connect L1, L2, L3 and N
 - a) Ensure a 10A three phase CB protects the meter.

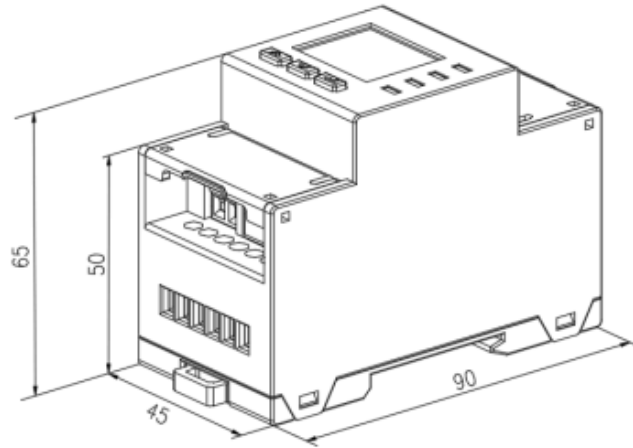

Figure 21: Physical dimensions of the ADL400N, excerpt from the ADL400N manual



Figure 22: ADL400N showing L1 and N Wired (single phase)

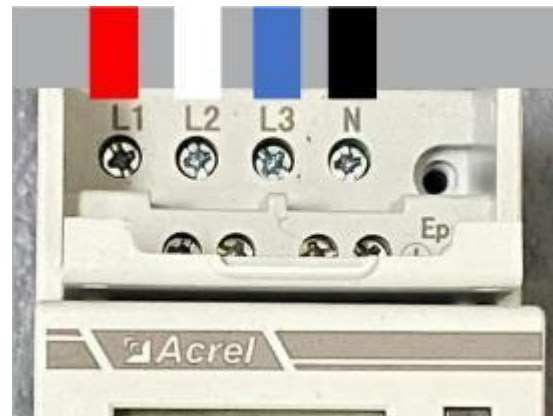

Figure 23: ADL400N showing L1, L2, L3 and N Wired (3-phase)

4. RS-485 cable shall be twisted pair cable, using a single pair from an Ethernet cable is acceptable.
 - a) Run blue and white RS-485 lines into the unit and connect to terminal block, ensuring:
 - i. Blue goes into pin A+ on the meter, pin 1 in the unit.
 - ii. White goes into pin B- on the meter, pin 2 on the unit.

Meter pin (Acrel)	Wire Colour	Filter board pin
A(+)	Blue	1
B(-)	White	2

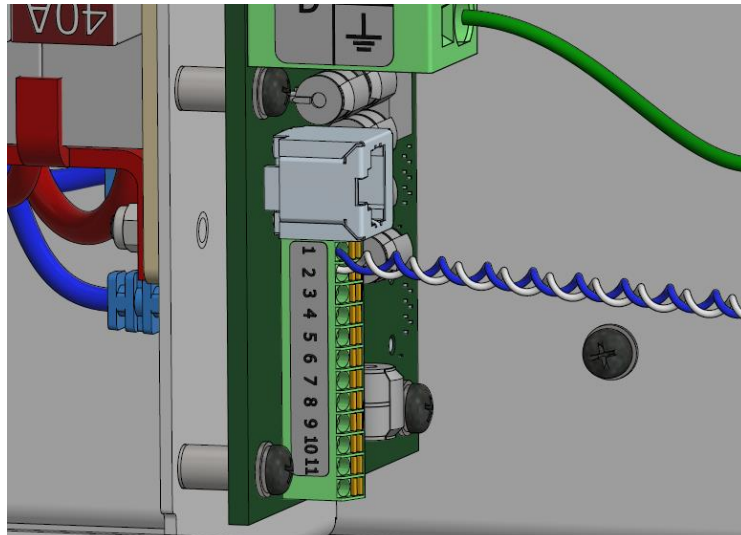

Figure 24 - Meter RS-485 connections inside the unit

5. The CT(s) must be clamped onto main house consumption live wire(s), with the arrow pointing towards the ElektroBank 14 (away from the grid input). Refer to Figure 28.
6. Follow below instructions for connecting the CT(s) to the ADL400N.
 - a) Single Phase
 - i. Connect L1 port to live and N port to Neutral
 - ii. Only a single CT should be connected to the meter. The red (L) wire should be placed in the I+ port and the black (CT) one placed into the I- port as per Figure 25 below.

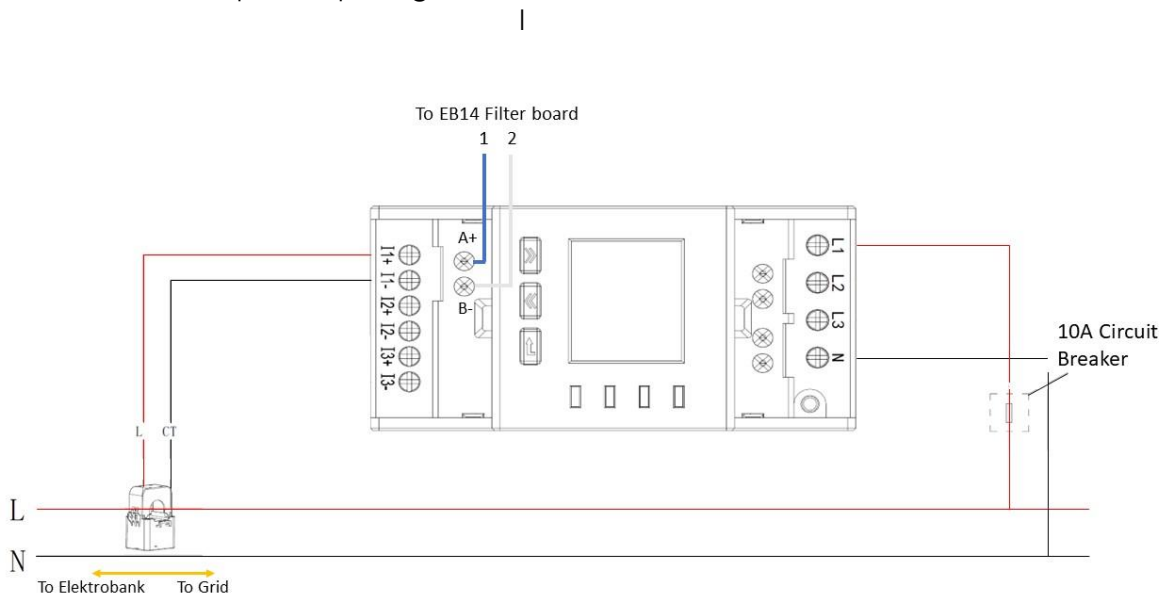

Figure 25: ADL400N Single Phase Wiring Diagram

- b) 3-Phase

- i. 3 CTs should be connected to the connectors at the bottom of the meter.
- ii. For the first phase, the red (L) wire should be placed into the I1+ port, and the black (CT) one placed into the I1- port. Continue as per Figure 26 for the other phases (L2 and L3).

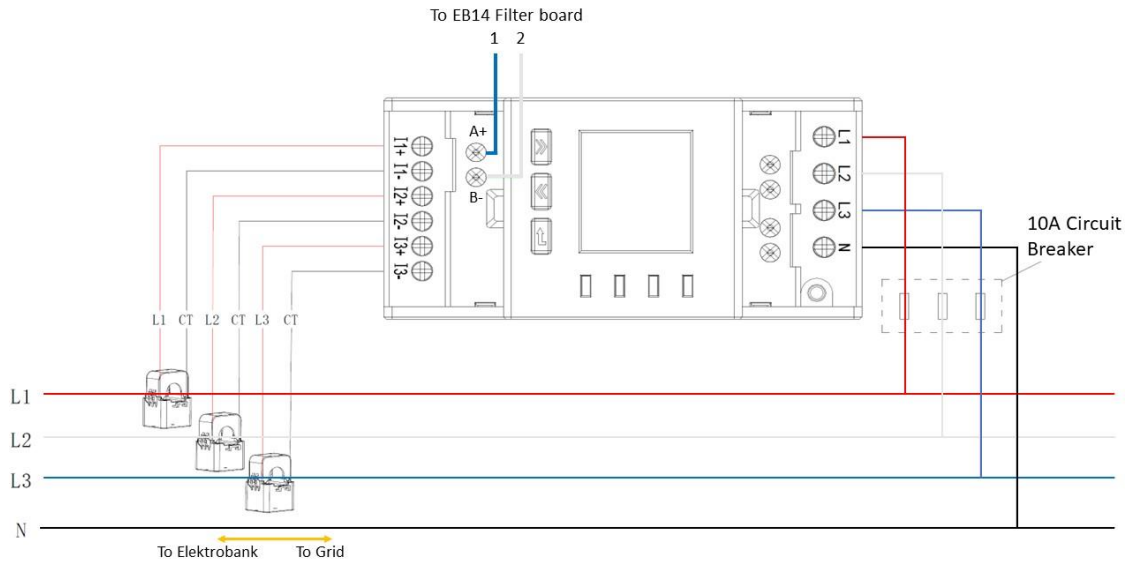

Figure 26: ADL400N 3-Phase Wiring Diagram



Figure 27: ADL400N wired for 3-phase



Notice It is critical that Phase Voltages and CT positions are aligned and that the CT is connected in the correct direction. If incorrect then fault finding is complex and time consuming.

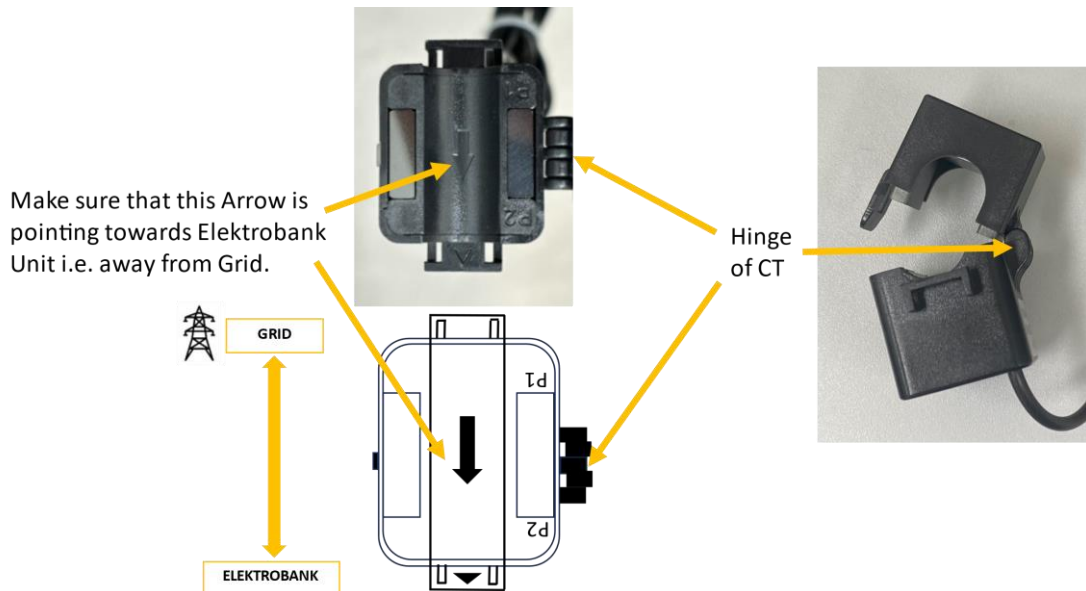

Figure 28 - CT (top view & side view) showing arrow and direction of ElektroBank 14 and Grid

12.2 External PV Meter (ADL400N-CT/D16)

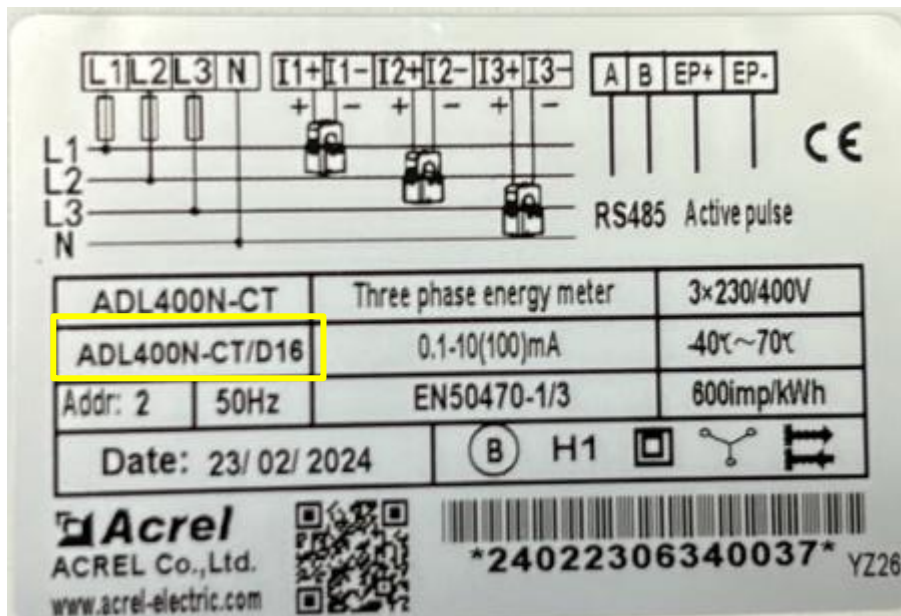

Figure 29 - ADL400N-CT/D16

1. If the site has an additional external PV inverter, then an additional ADL400N meter (PN: ADL400N-CT/D16, without the "(EMP)" suffix designation) should be installed

to measure the PV generation. Use the wiring diagrams above for single phase (Figure 25) or 3-phase (Figure 26).

2. It should be connected in the same way, **with the CTs pointing towards the external inverter (away from the grid input).**
3. The RS-485 bus should parallel off the consumption meter, so pin A+ connects to pin A+ and pin B- connects to pin B-.
4. The supplied external PV meter will be a different part number than the main consumption meter. It needs to be checked that it:
 - a. DOES NOT have a 120R resistor fitted internally. To test measure resistance between A and B before wiring up and it should measure >10kohms.
 - b. **The address of the meter needs to be set to 002 (see Appendix A to verify or change the address).**

13 Commissioning

13.1 Closing Unit

1. Write down the password that is located on the sticker along the inside door of the unit or also located on the included hardcopy installation manual, which will be used for accessing the Installation Wizard in the next section.



Figure 30: Picture showing location of serial number and password inside the enclosure



Figure 31: Picture of the printed manual showing location of serial number and password.

2. Ensure PV supply is isolated at the local isolation switch.
3. Ensure grid supply is isolated at the main switchboard (and at separate AC isolation switch if present).
4. Place wiring escutcheon panel back on and close lid.
5. Turn on battery circuit breaker.
6. Turn grid and backup circuit breakers on inside the unit.
7. Ensure you have removed the manual (or taken a photo of the Wifi hotspot details from the inside door).
8. Close the main door and secure with a single screw.
9. Turn grid power on at the switchboard and local AC isolator (if present).
10. Confirm LED on the front cover lights up. Note that Section 18 Appendix C – LED Codes explains what the different colours and patterns mean.
11. Wait until it goes red (this can take a few minutes).
12. Next proceed to Section 13.2 Installer Dashboard.



Note: Once turned on, the unit will have a red light on the front cover after a minute or so. This is correct behaviour until it has been commissioned, at which point the LED will turn to yellow/orange. Refer to Section 18 Appendix C – LED Codes for more information.



Once turned ON, do not turn off the unit until all software updates are completed, otherwise there is a risk of permanently damaging the unit and it will need to be sent back to the manufacturer.

13.2 Installer Dashboard

13.2.1 Prerequisites

- An internet enabled browser
Note: A PC or tablet is recommended for configuring the system, as a mobile phone may be too small to display the interface and field properly.
- A registered Installer account.
- Device previously setup for multi-factor authentication (MFA) to allow login.

13.2.2 Accessing the Installer Dashboard

1. In a browser type 'https://installer.ElektroBank.com.au/' and login using your registered installer account. Only Empower Energy certified installers will have a registered account.

Note: When the ElektroBank 14 is powered on, it uses an in-built 4G connection to access the internet. If the site is outside of 4G signal, then please contact Empower Support at +61 (0)2 8745 8835 for step-by-step instructions.



The ElektroBank 14 can only be commissioned by an Empower certified installer. To become a certified installer, you must complete a formal training process. Further information about the process is described in document 9000066 Empower Installer Certification Process at www.empowerenergy.com.au.

13.2.3 Adding a unit to the Installer Dashboard

1. Click on “Add ElektroBank”

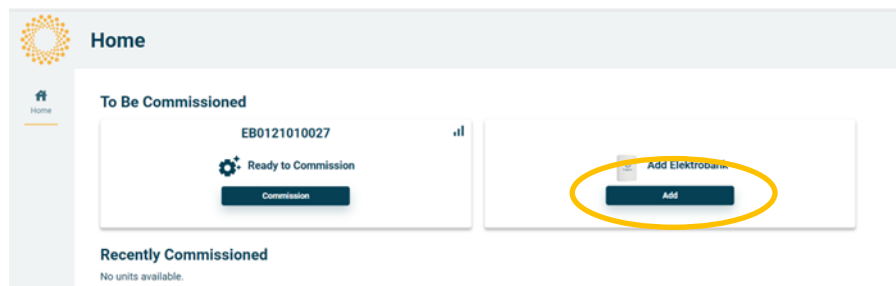

Figure 32: Screenshot showing how to add an ElektroBank to the Installer Dashboard

2. Enter the serial number of the unit and the password. The password is on a sticker on the inside door of the ElektroBank 14 unit (where the printed collateral is stored – refer to Figure 30) and is called the ‘WiFi PW’. It is also affixed to the front page

of the installer manual supplied with the device. Please write the password down (or take a photo) as it will be required for future steps.

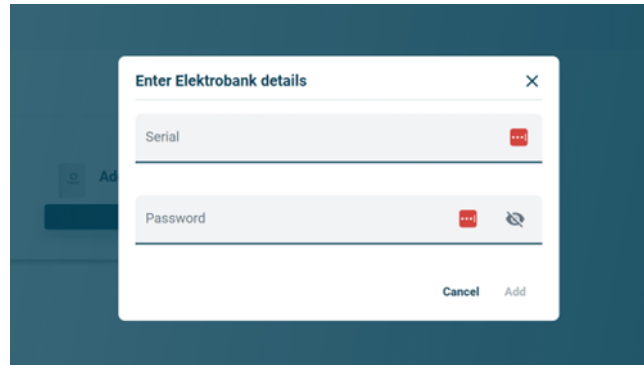

Figure 33: The serial number and password are required to add an ElektroBank 14 to the installer dashboard

3. The ElektroBank 14 unit should appear on the "To Be Commissioned" column on the Installer Dashboard.

13.2.4 Connect to the ElektroBank

1. Click "Connect" and enter the same password from 13.2.3.

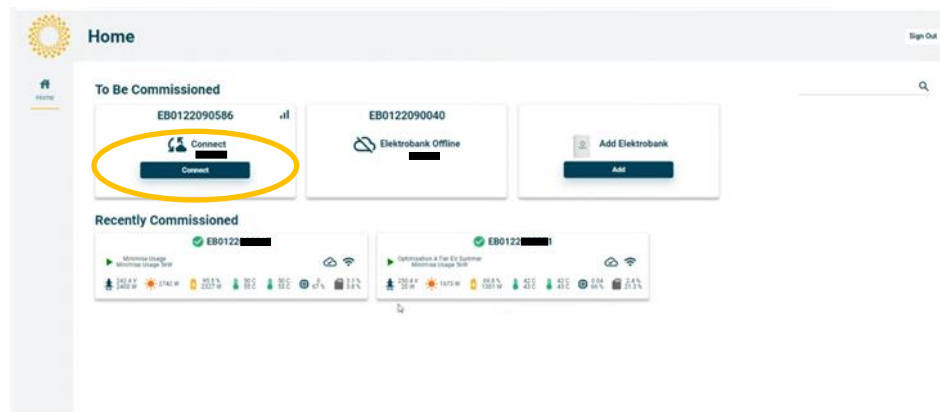

Figure 34: Click "Connect"

2. From the Installer Dashboard you must first upgrade the firmware, then initiate the battery, and then configure network settings (e.g. Wi-Fi or ethernet) before you can start the Installation Wizard and complete commissioning of the unit.

13.2.5 Upgrade Firmware,

4. Click the **Upgrade** button to initiate the upgrade.
*Note: **Firmware upgrades generally take up to 20 minutes.** Empower recommend initiating the upgrade as early as possible in the installation process so other installation tasks (e.g PV installation or labelling) at site can be performed while the unit is completing the upgrade.*



Figure 35: Click Upgrade Now to start the upgrade



DO NOT power cycle the ElektroBank 14 during the upgrade. It may be irreparably damaged.



Figure 36: During the Upgrade various patches will be applied



The messages that pop up may seem out of sequence so generally ignore them. If after 30 minutes the upgrades have not completed, then call Empower for support.

13.2.6 Battery Initialisation

1. Click the Initialise Battery button to initialise the Battery.



Figure 37: Click Initialise to start the initialisation process

13.2.7 Network Settings

1. The ElektroBank 14 connects to the internet via Ethernet, Wi-Fi or 4G. The 4G connection is managed exclusively by Empower and is only provided for a short time, so the Owner must provide access to their internet connection via Ethernet or Wi-Fi.
2. Click the button that says Configure.



Figure 38: Click Configure to setup the Wi-Fi and/or Ethernet

- Follow the onscreen instructions to setup Ethernet or Wi-Fi.
Note: You can skip configuration of the network settings and proceed directly to the Installation Wizard, but before commissioning can be completed, the network settings must be configured and connected.

13.3 Installation Wizard

13.3.1 Installation Wizard: Start

- Ready to Commission: Click "Commission" and the Installation Wizard will appear. Follow the onscreen instructions to configure and test the ElektroBank 14 to complete commissioning.

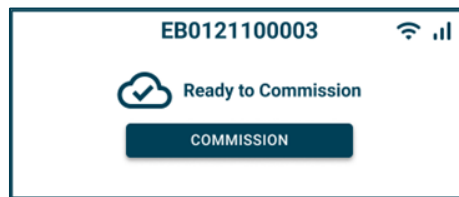

Figure 39: Start the installation Wizard by clicking Commission

13.3.2 Installation Wizard: Site Details

This section collects details about the site such as NMI, Address, DNSP, Phase, Backup Connection, AS4777 Grid Configuration and PV Configuration.

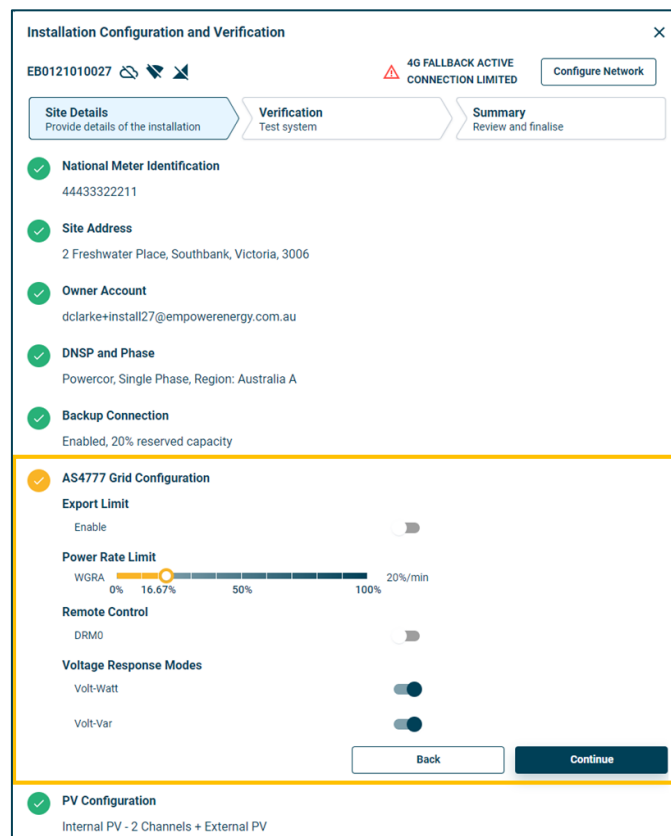

Figure 40: Site Details section showing where the configurable AS4777 Grid Settings

There is a prompt to initiate the Owner Account Setup. This can be bypassed and completed later but Empower recommends doing this before progressing with the Installation Wizard, so the customer has time to register a user account and download the Owner App before the system is commissioned.



Note, the system cannot be commissioned until the Owner Account Setup step has been completed.

13.3.3 Installation Wizard: Verification

This section runs through both automated and manual checks to make sure the unit and its peripherals are all wired correctly.

13.3.3.1 Initial Verification

Confirms grid wiring and switchboard has been installed correctly.

13.3.3.2 Meter Verification

For single phase installs this test automatically verifies that the meter measuring house consumption has been installed with the correct polarity

If the meter is connected in a 3-phase configuration then the wizard requires a heat load (normally a ~1kW heat gun) be connected to each phase in turn. It should be confirmed manually that each phase increases by the rated power of the heat load whilst it is applied.

13.3.3.3 PV Test

This test verifies that both MPPT channels are providing the correct voltages and some power flow.

It is possible to postpone the PV test if the PV was installed but there is not enough light to complete this step or solar is scheduled for install at a later date. The verification can be completed remotely, provided the wiring is correct and protection circuits are activated.

13.3.3.4 Backup Test

This test confirms the ElektroBank 14 can provide backup during a grid outage. During this test electricity to the home will drop out briefly (including Wi-Fi and Ethernet) and the unit will fall back to 4G. The communication to the ElektroBank 14 will return momentarily.

13.3.4 Installation Wizard: Summary

Provides an overview of the configuration and verifies all critical steps have been completed before completing final commissioning.

13.3.4.1 Site and Grid Details

Provides a summary of the Site Details completed in the earlier section.

13.3.4.2 PV Configuration

Provides a summary of the PV Configuration completed in the earlier section.

13.3.4.3 Finalise Installation and Start Calibration

A battery calibration is necessary to establish the initial state of the battery. Depending on the state of the battery this process could take between 1 to 7 days, and battery will not be available for owner use for the duration of the process.

13.3.4.4 Commissioning Unit

This is where final commissioning takes place. This section will verify that the

1. System is installed,
2. Battery is calibrating/calibrated,
3. Owner account setup has been triggered, and
4. Network is configured.

If all these steps are verified, then the final Commission Unit button will become accessible.

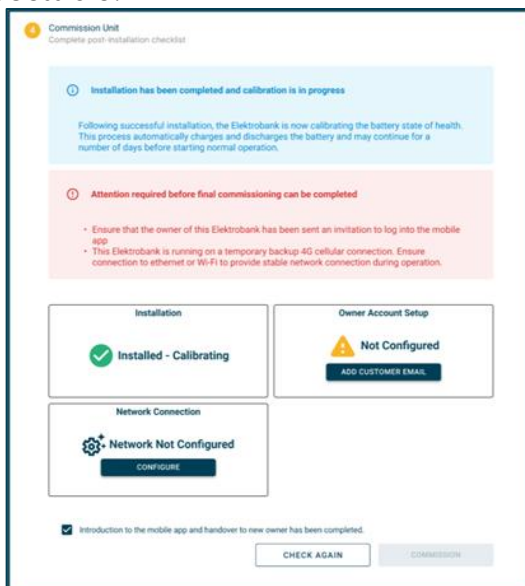

Figure 41: Example showing some steps not completed, which prevents final commissioning.

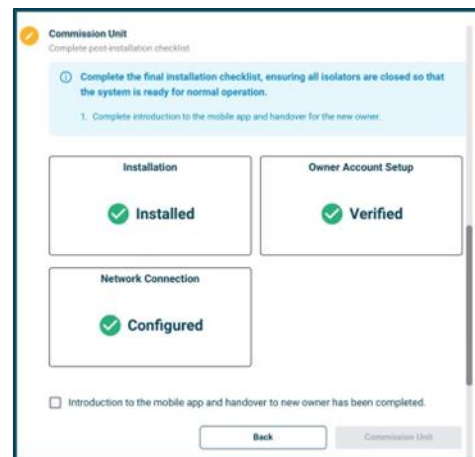

Figure 42: Example showing all steps completed, ready for final commissioning

13.3.5 After Commissioning

Once the unit is commissioned completed ensure the main door is shut and locked with all screws tightened to 1Nm.



Notice

Once commissioned the LED on the front of the unit will turn yellow. Unit settings and configuration will no longer be accessible, and you will need to contact Empower to re-commission the system.

13.4 Before Leaving Site

13.4.1 Remove rubber feet

Make sure to remove and dispose of the rubber feet at the base of the enclosure. These are intended to prevent scuffing of the enclosure while manoeuvring it during installation.

13.4.2 Earth Fault Alarm

This inverter complies with IEC 62109-2 clause 13.9 for earth fault alarm monitoring.

If an Earth Fault Alarm occurs:

1. The text 'RCD fault' or 'PV Insulation Test Fault' will be displayed on the inverter web-based monitoring portal
2. The LED indicator will turn red and the built in audible buzzer alarm will turn on.

13.4.3 User Training

The installer shall ensure the end user is registered, that the app is functional and give them ~2-5 minutes training on how the app works.

1. If the end-user is having challenges registering or logging into the app, the installer shall assist with troubleshooting.
2. The installer shall show the user how to connect to the unit via the Owner App and click through the app to confirm everything is functioning correctly.

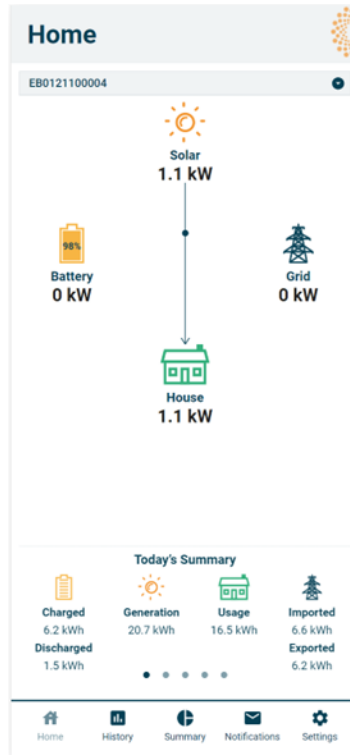

Figure 43: Home page of the Owner App

3. Explain the concept of Battery Reserve and show them how they can adjust this via the Settings page. The default battery reserve is None and means the battery will provide the best economic return but may be empty if required for a backup event.

For best financial performance we strongly recommend the Battery reserve is set to 'None'

- Choosing a Battery Reserve of **100%** means the ElektroBank 14 unit will maintain the battery at full capacity for grid backup events (e.g. when the grid is not available) but won't discharge to offset the house load while the grid is connected. Obviously this is not recommended!
- Choosing a Battery reserve of **None** means the entire capacity of the battery will be available for discharge during daily operation, however if a grid backup event occurs, there is the possibility that the battery has been fully discharged, so cannot provide backup if the house load is greater than the solar generation.

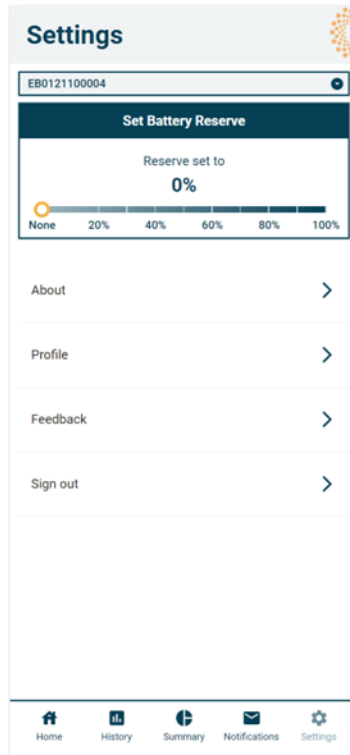

Figure 44: Settings page of the Owner App showing where Battery Reserve is accessible

13.4.4 Changing inverter settings

1. Following commissioning of the system, access to the unit's configuration and status will be limited through the Installer Dashboard and mostly in a 'read only' state. If settings need to be adjusted the installer will need to contact Empower to re-do the Installation Wizard and re-commission the system.

13.4.5 Viewing Read-Only Settings

The country grid code, protection settings, power quality response modes, region settings, firmware version and other installer settings can be viewed in a read only format by logging into the local webserver built into the ElektroBank unit.

1. Connect to the ElektroBank 14 via Wi-Fi. The Wi-Fi hotspot is always turned on. The SSID and password will be on a sticker on the inside door of the unit and also affixed to the front page of the installer manual.
2. In a browser type 'http://ElektroBank/' (or IP address 192.168.20.1/) and login as username: admin, password: admin and the read only settings are available as below

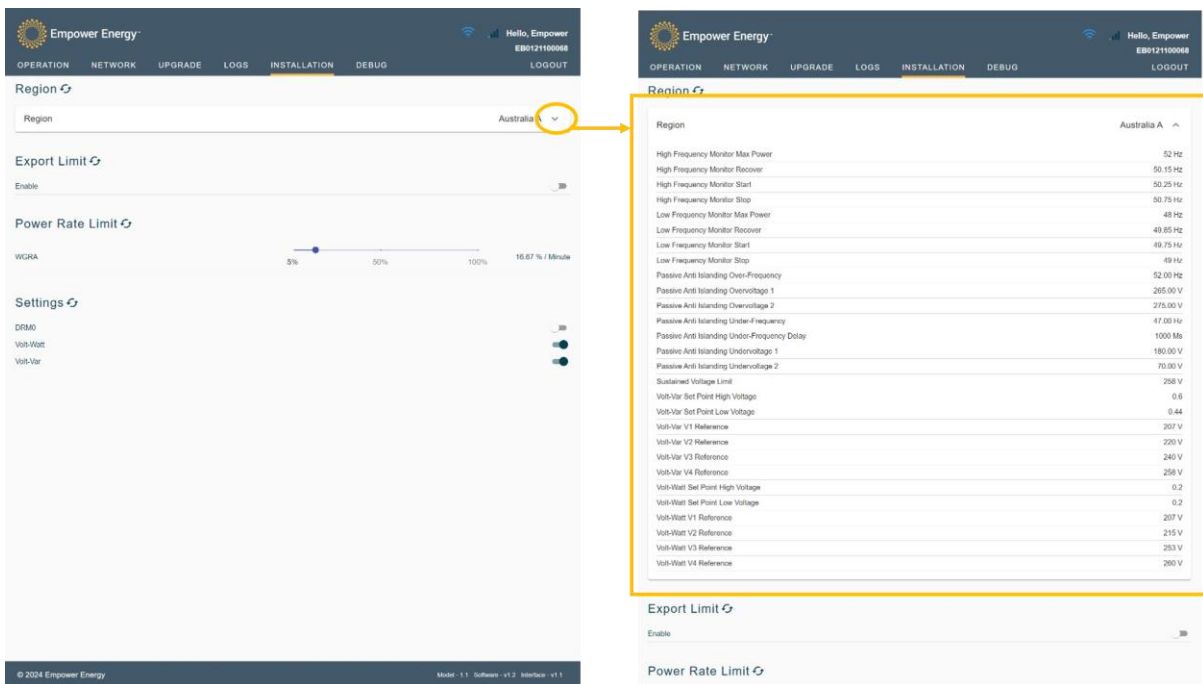

Figure 45: Settings accessible via Wi-Fi hotspot

14 Maintenance

14.1 User Maintenance

1. **The user is not allowed to remove any covers on the ElektroBank 14, only a trained professional is permitted to do this.**
2. The ElektroBank 14 does not require scheduled maintenance and only requires an external debris and salt clean, recommended every 6 months by the user.
3. Check for signs of ingress by insects, animals, plants or water/dust. Check for any signs of corrosion. Call your service technician if you see any signs.
4. Then, with a damp cloth or soft brush, clean the whole product. Make sure all debris is cleared.

14.2 Trained Service Professional Maintenance



If turning the unit off for an extended period, ensure the unit is fully charged beforehand to avoid draining the batteries below their low voltage threshold, which will void the warranty.

Scheduled maintenance by a service professional is not required.

If maintenance is required, always ensure the unit is completely de-powered and isolated before opening the main door and before removing the internal escutcheon panel.

14.2.1 Turning OFF the Unit

1. Ensure grid voltage is isolated with an external locked off circuit breaker or isolator switch.
2. Ensure backup voltage is isolated with a locked off circuit breaker or isolator switch.
3. Ensure PV connectors are disconnected, or PV isolators are OFF and locked.
4. Open the main door
5. Turn off grid and backup circuit breakers inside the unit
6. Turn OFF Battery Circuit Breaker inside the unit near the top
7. Ensure there is no LED light on the front of the unit
8. Wait for 15 minutes for DC capacitors to decay
9. Remove the bottom escutcheon panel and using a multimeter check all terminals are not live.
10. Never remove the top escutcheon panel.

14.2.2 Turning ON the Unit

1. Ensure grid voltage is isolated with an external locked off circuit breaker or isolator switch.
2. Ensure backup voltage is isolated with a locked off circuit breaker or isolator switch.
3. Ensure PV connectors are disconnected, or PV isolators are OFF and locked.
4. Open the main door

5. Turn on **battery circuit breaker** at the top of the unit
6. Turn on the **grid and backup circuit breakers** near the bottom of the unit.
7. Close the door and do up the screws in the order shown in Figure 14 to 0.5Nm
8. Then in the same sequence tighten to 1Nm
9. Turn on the external grid and backup isolators
10. Turn on the PV isolators
11. The LED on the front door should now light up if the unit is being powered from grid correctly.
12. Before leaving site double check that all isolators are closed and check on the customers app that power flow is being reported either from the solar or battery or both and that there are no faults shown.

15 Electrical Ratings

PV Input	
Type of Voltage	DC, OVC II
Vmax PV	430V
Max PV Continuous/PV Short Circuit Current	15A / 19A
PV MPPT Starting Voltage	150V (then works down to 100V for hysteresis)
PV MPPT Operating Range	100V – 430V
PV Power	4kW per MPPT (8kW total)
Max inverter back feed current to the array	7mA
PV Safety	PV is non-isolated, floating voltage at grid potential, external isolation device required
AC Input / Output Ratings (Grid port)	
Type of Voltage	AC, OVC III. Only connected to TN system where Neutral should always be connected to earth at the single point earth connection in the property.
Frequency	50Hz
Voltage (nominal)	230V
Maximum Input/Output Current	41.7Arms / 21.7Arms
Inrush Current	~50Arms for 100ms (excluding any backup loads)
No. of Phases	1
Maximum Active/Apparent Power Input	9.6kW / 9.6kVA
Maximum Active/Apparent Power Output	5kW / 5kVA
Power Factor	+/- 0.6
Maximum Overcurrent Protection	40A rms
Maximum Fault Current	90A rms
Standby Power	Approx. 16W
AC Output Ratings (Backup Port)	
Type of Voltage	AC, OVC III. Neutral is internally connected to Grid port so has continuity to earth at the single point earth connection in the property
Frequency	50Hz
Voltage (nominal)	230V
Maximum Continuous Current	15Arms
Rated short time withstand current (Icw)	6kA
Active/Apparent Power Continuous	3.5kW/3.5kVA
Active/Apparent Power Overload	4.6kW / 4.6kVA for 1 hour
Maximum/Inrush Current	30Apeak for 1s
Power Factor	+/-0.6
Number of Phases	1
Maximum Output Overcurrent Protection	40A rms
Maximum Output Fault Current	90A rms
Battery	
Voltage (nominal)	154V, OVC II
Voltage (range)	120-175V
Maximum Continuous Current Charge & Discharge	32A
Maximum Continuous Power Charge & Discharge	5kW
Battery Type	Lithium Iron Phosphate
Battery Capacity	15.4kWh maximum, 13.9kWh useable (at 90% Depth of Discharge)
Battery Short Circuit Current	~3000A
System	
Communications	WiFi, Ethernet, 3G/4G, RS-485 to front of house meter
Residual Current Monitoring	Integral for grid port (backup port requires Type A RCD)
Inverter Topology	Non-isolated
Inverter type	Multiple mode inverter with Grid interactive and standalone modes
Protective Class	I
Active Anti-Islanding Method	Frequency Instability
Supporting Demand Response Modes	DRM0
Certification Marks	AS4777.2:2015, IEC62109-1, IEC62109-2, AS62040.1, AS61000.6.3:2012, IEC 62619
Mechanical & Environmental	
Ambient Operating Temperature Range	-20 to 50° C for outdoor unconditioned without solar effects (power auto-derates above 40° C and below 4° C)
Recommended Operating Temperature	10 to 30° C
Ingress Protection (IP) rating	IP 66
Dimensions	1200mm / 900mm / 225mm
Weight	180kg
Environmental/Wet Location Category	Outdoor / Wet
Pollution Degree	PDII
Operating Relative Humidity	Up to 100%, condensing
Maximum Altitude	2000m

16 Appendix A - Meter programming

16.1 Programming the ADL 400N meter

The meter will come pre-programmed and the installer should not need to change anything.

This section was included for troubleshooting purposes in case some of the settings are incorrect.

The minimal connection for programming is a 230v connection between **L1** and **N** on the top panel.

To change a setting, press \leftarrow until a digit starts to flash.

To change that digit, use the ∇ button.

To move to the next digit, use the Δ button

1. Hold \leftarrow for 3 seconds
2. Enter the password 0001 and press \leftarrow
3. Verify the following:
 - a. Addr: 001 (002 for external PV meter)
 - b. bAud: 38.4
 - c. PAri: None
 - d. LEd: 60
 - e. PL: 3P4L
 - f. UPri: 220
 - g. iPri: 30
 - h. UMSK: 20
 - i. iMSK: 10
 - j. PULS: 600
 - k. S-ty: RMS
 - l. diSP: Auto
 - m. PHSq: OFF
 - n. CoDE: 1
4. Then hold \leftarrow for 3 seconds to save
5. Use Δ / ∇ buttons to select Yes, and press \leftarrow

17 Appendix B – Single Phase Wiring Diagram



Note: This diagram is only to be used as an approximate guide, Installation shall follow and comply with AS/NZS 5139, AS/NZS 3000 as well as any other requirements from this manual.

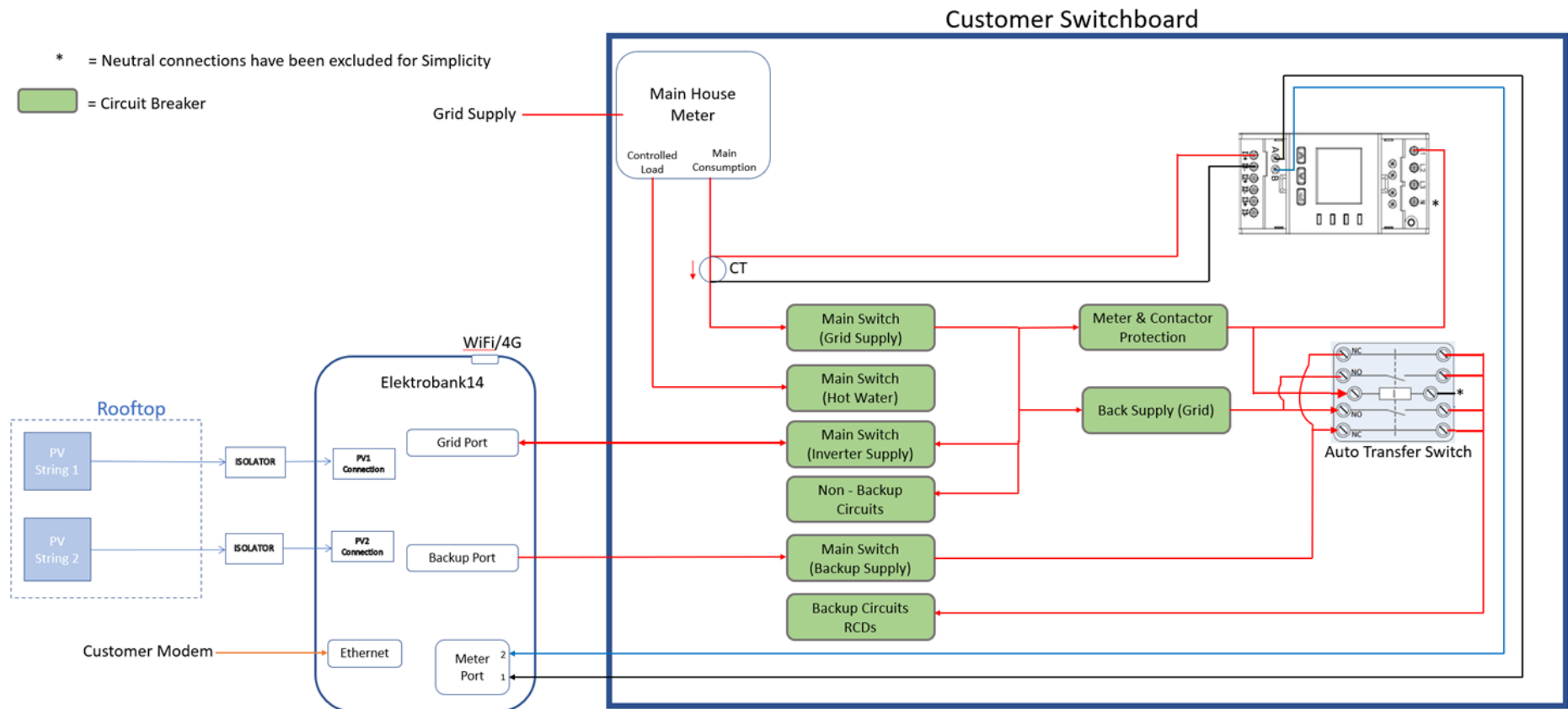

18 Appendix C – LED Codes

Colour	Pattern	Meaning	Action
Empower yellow	Solid	Normal operation	No action require. Normal operation
Green	Pulsing	Backup mode active	If unintentional, then check grid circuit breakers are all turned on and wiring is correct
Red	Solid	Fault	Look at Installation Wizard or customer app for details on the fault for further troubleshooting
Pink-Purple	Pulsing	No active internet connection	Connect Ethernet to an active internet connection or configure the ElektroBank 14 unit's Wi-Fi via the built-in hotspot. See Section 13.4.5 for instructions on how to connect to the built-in hotspot of the ElektroBank 14 and access its settings.
Green	Solid	Fallback to built-in 4G internet backup	Connect Ethernet to an active internet connection or configure Wi-Fi settings via the Installation Wizard (or customer app)
White	Solid	Pre-booting	Call Empower
White	Pulsing	OS is booting	Call Empower
Blue	Solid	System Apps not started	Call Empower
Blue	Pulsing	Upgrade in progress	Wait until finished and don't turn power off!

Table 4: LED Colour Codes Meanings